

OWNER'S MANUAL
PARTY 910-912-915-920 CANADA



TABLE OF CONTENTS

TABLE OF CONTENTS	1
INTRODUCTION	2
MEMORY HELP SHEET	3
SAFETY INSTRUCTIONS	4
SAVE THESE INSTRUCTIONS	6
IMPORTANT ELECTRICAL SAFETY INSTRUCTIONS	8
SAFETY SIGN	9
LOCATION AND INSTALLATION	10
ELECTRICAL SPÉCIFICATIONS.....	11
SITE PREPARATION	14
STARTING UP THE SPA.....	16
HOT TUB WATER BALANCE – GENERAL OVERVIEW	17
SAFETY INSTRUCTIONS FOR PRODUCTS	17
WATER CHEMISTRY.....	18
CONTROL ACCESSORIES	20
WATER BALANCE TROUBLESHOOTING	22
ROUTINE HOT TUB MAINTENANCE	23
CLOSING PROCEDURE	24
KEYPAD IN. K500 (910)	25
AUDIO IN.K500 (OPTIONAL 910).....	31
KEYPAD IN. K1000 (920).....	33
IN TOUCH 2 WIFI GECKO (OPTIONAL)	46
WARRANTY	50
TROUBLESHOOTING.....	51

MEMORY HELP SHEET

In order to assist you in the installation and maintenance of your spa, please fill in the following information and keep them for future reference.

The warranty of your spa comes into effect on the date of purchase. It is your responsibility to refer to your owner's manual to keep your warranty.

To qualify for the warranty, you will need to provide your spa information to your dealer (refer to the memo card) as well as a photo of the room.

Spa Information

Model : _____

Color: _____

Serial number: _____

Date of purchase: _____

Delivery date: _____

Serial number is located on a data plate outside the cabinet at ground level directly below the topside control panel. When calling for service, please have your serial number on hand.



Retailer

Company: _____

Address: _____

Phone: _____

Contact: _____

SAFETY INSTRUCTIONS

SAVE THESE INSTRUCTIONS IMPORTANT USER SAFETY INSTRUCTIONS

Your physiological response to hot water is subjective and depends on your age, health, and medical history. If you don't know your tolerance to hot water, or if you get a headache, or become dizzy or nauseous when using your spa / hot tub, get out and cool off immediately.

WARNING

1. CHILDREN SHOULD NOT USE SPAS OR HOT TUBS WITHOUT ADULT SUPERVISION.
2. DO NOT USE SPAS OR HOT TUBS UNLESS ALL SUCTION GUARDS ARE INSTALLED TO PREVENT BODY AND HAIR ENTRAPMENT.
3. PEOPLE USING MEDICATIONS AND/OR HAVING ANY ADVERSE MEDICAL HISTORY SHOULD CONSULT A PHYSICIAN BEFORE USING A SPA OR A HOT TUB.
4. PEOPLE WITH INFECTIOUS DISEASES SHOULD NOT USE A SPA OR HOT TUB.
5. TO AVOID INJURY, EXERCISE CARE WHEN ENTERING OR EXITING THE SPA OR HOT TUB.
6. DO NOT USE DRUGS OR ALCOHOL BEFORE OR DURING THE USE OF A SPA OR HOT TUB, TO AVOID UNCONSCIOUSNESS AND POSSIBLE DROWNING.
7. PREGNANT OR POSSIBLE PREGNANT WOMEN SHOULD CONSULT A PHYSICIAN BEFORE USING A SPA OR HOT TUB.
8. WATER TEMPERATURE IN EXCESS OF 100°F MAY BE INJURIOUS TO YOUR HEALTH.
9. BEFORE ENTERING THE SPA OR HOT TUB, MEASURE THE WATER TEMPERATURE WITH AN ACCURATE THERMOMETER.
10. DO NOT USE A SPA OR A HOT TUB IMMEDIATELY FOLLOWING STRENUOUS EXERCISE.
11. PROLONGED IMMERSION IN A SPA OR HOT TUB MAY BE INJURIOUS TO YOUR HEALTH.
12. DO NOT PERMIT OR USE ELECTRIC APPLIANCES (SUCH AS LIGHT, TELEPHONE, RADIO OR TELEVISION) WITHIN 5FT OF THIS SPA OR HOT TUB.
13. CHILDREN SHOULD NOT ENTER A HOT TUB WHERE THE WATER TEMPERATURE EXCEEDS BODY TEMPERATURE (98.6°F).

14. DO NOT ALLOW CHILDREN TO SUBMERGE THEIR HEAD UNDER WATER.

15. NEVER OPERATE THE HOT TUB PUMP AT HIGH SPEED WITHOUT HAVING ALL SUCTION AND RETURN LINES OPEN.

16. ALWAYS KEEP THE HARDCOVER INSTALLED AND LOCKED WHEN THE HOT TUB IS NOT IN USE.

17. TEST THE GFCI (GROUND FAULT CIRCUIT INTERRUPTER) MONTHLY.

18. POST EMERGENCY PHONE NUMBERS FOR POLICE, FIRE DEPARTMENT, AND AMBULANCE AT THE NEAREST PHONE.

19. TO REDUCE THE RISK OF INJURY

THE WATER IN A SPA SHOULD NEVER EXCEED 104°F.

WATER TEMPERATURES BETWEEN 100°F AND 104°F ARE CONSIDERED SAFE FOR A HEALTHY ADULT. LOWER WATER TEMPERATURES ARE RECOMMENDED FOR YOUNG CHILDREN AND WHEN SPA USE EXCEEDS 10 MINUTES.

SINCE EXCESSIVE WATER TEMPERATURES HAVE A HIGH POTENTIAL FOR CAUSING FETAL DAMAGE DURING THE EARLY MONTHS OF PREGNANCY, PREGNANT OR POSSIBLY PREGNANT WOMEN SHOULD LIMIT SPA WATER TEMPERATURES TO 100°F.

BEFORE ENTERING A SPA, THE USER SHALL MEASURE THE WATER TEMPERATURE SINCE THE TOLERANCE FOR WATER TEMPERATURE REGULATING DEVICES VARIES.

THE USE OF ALCOHOL, DRUGS, OR MEDICATION BEFORE OR DURING SPA USE MAY LEAD TO UNCONSCIOUSNESS, WITH THE POSSIBILITY OF DROWING.

OBESE PERSONS AND PERSONS WITH A HISTORY OF HEART DISEASE, LOW OR HIGH BLOOD PRESSURE, CIRCULATORY SYSTEM PROBLEMS OR DIABETES SHOULD CONSULT A PHYSICIAN BEFORE USING A SPA.

PERSONS USING MEDICATION SHOULD CONSULT A PHYSICIAN BEFORE USING A SPA SINCE SOME MEDICATION MAY INDUCE DROWSINESS WHILE OTHER MEDICATION MAY EFFECT HEART RATE, BLOOD PRESSURE AND CIRCULATION.

SAVE THESE INSTRUCTIONS

IMPORTANT SAVE THESE INSTRUCTIONS

Your physiological response to hot water is subjective and depends on your age, health, and medical history. If you don't know your tolerance to hot water, or if you get a headache, or become dizzy or nauseous when using your hot tub, get out and cool off immediately.



CAUTION

MAINTAIN WATER CHEMISTRY IN ACCORDANCE WITH THE MANUFACTURER'S INSTRUCTIONS.

WARNING!



NO FLOATER! NO TRI-CHLOR!

Tri-Chlor is very corrosive to the spa surface - above and below the water - and can affect pumps and jets.

Lucite.SPA | *EasyCare.*

Visit plaskolite.com for more information.



DANGER

- **RISK OF ACCIDENTAL DROWNING. EXTREME CAUTION MUST BE EXERCISED TO PREVENT UNAUTHORIZED ACCESS BY CHILDREN. TO AVOID ACCIDENTS, ENSURE THAT CHILDREN CAN'T USE THE SPA UNLESS THEY ARE SUPERVISED AT ALL TIMES.**
- **2RISK OF INJURY. THE SUCTION FITTINGS IN THIS SPA ARE SIZED TO MATCH THE SPECIFIC WATER FLOW CREATED BY THE PUMP. SHOULD THE NEED ARISE TO REPLACE THE SUCTION FITTINGS OR THE PUMP, BE SURE THAT THE FLOW RATES ARE COMPATIBLE. NEVER OPERATE THE SPA IF THE SUCTION FITTINGS ARE BROKEN OR MISSING. NEVER REPLACE A SUCTION FITTING WITH ONE RATED LESS THAN THE FLOW RATE MARKED ON THE ORIGINAL SUCTION FITTING.**
- **RISK OF ELECTRIC SHOCK. INSTALL AT LEAST 1.5M (5FT) FROM ALL METAL SURFACES. AS AN ALTERNATIVE, A SPA MAY BE INSTALLED WITHIN 1.5M (5FT) OF METAL SURFACES IF EACH METAL SURFACE IS PERMANENTLY CONNECTED BY A MINIMUM 8 AWG (8.4 mm²) SOLID COPPER CONDUCTOR TO THE WIRE CONNECTOR ON THE TERMINAL BOX THAT IS PROVIDED FOR THIS PURPOSE.**
- **RISK OF ELECTRIC SHOCK. DO NOT PERMIT ANY APPLIANCE, SUCH AS A LIGHT, TELEPHONE, RADIO, OR TELEVISION, WITHIN 1.5M (5FT) OF THE SPA**

HYPERTHERMIA

HYPERTHERMIA Since your hot tub can be set to reach temperatures of 104° F, users should be aware that extended submersion in water that exceeds normal body temperature can lead to hyperthermia.

The causes, symptoms and effects of hyperthermia may be described as follows:

Hyperthermia occurs when the internal temperature of the body reaches several degrees above the normal body temperature of 98.6°F. The symptoms of hyperthermia include drowsiness, lethargy, and an increase in the internal temperature of the body. The effects of hyperthermia include:

Unawareness of impending hazard; Failure to perceive heat; Failure to recognize the need to exit the hot tub; Physical inability to exit the hot tub; Fetal damage in pregnant woman; Unconsciousness resulting in the danger of drowning

If you sense any of the symptoms of hyperthermia, safely exit the hot tub immediately.



WARNING

THE USE OF ALCOHOL, DRUGS OR MEDICATION CAN SIGNIFICANTLY INCREASE THE RISK OF FATAL HYPERTHERMIA.

IMPORTANT ELECTRICAL SAFETY INSTRUCTIONS

SAFETY COMES FIRST WHEN INSTALLING & USING THIS ELECTRICAL EQUIPMENT, BASIC SAFETY PRECAUTIONS MUST ALWAYS BE FOLLOWED!

1. READ AND FOLLOW ALL INSTRUCTIONS.

2. Electrical installation must be completed by a qualified electrician in accordance with all National, Regional and Local Codes and Regulations in effect at the time of installation.

3. Connect only to a dedicated circuit protected by a class "A" two-pole ground fault circuit interrupter (GFCI).

4. Use copper conductors only.

5. The hot tub equipment and all electrical plugs, outlets and lights within 1.5m (5 ft) of the unit must be GFCI protected. Consult your electrician or local electrical authority for further details.

6. A green colored terminal or a terminal marked "G", "GR", "Ground", or "Grounding" is located inside the supply terminal box or compartment. To reduce the risk of electric shock, this terminal must be connected to the grounding means provided in the electric supply service panel with a continuous copper wire equivalent in size to the circuit conductors supplying the equipment.

7. At least two lugs marked "BONDING LUGS" are provided on the external surface or on the inside of the supply terminal box or compartment. To reduce the risk of electric shock, connect the local common bonding grid in the area of the hot tub to these terminals with an insulated or bare copper conductor not smaller than No. 6 AWG (Canada/Europe) / No. 8 AWG (USA).

8. All field installed metal components such as rails, ladders, drains or other similar hardware within 3m (10 ft) of the hot tub shall be bonded to the equipment grounding bus with copper conductors not smaller than No. 6 AWG.

9. SAVE THESE INSTRUCTIONS.



WARNING

This guide is for standard installations where the wire run is 50 ft or less. For longer runs, consult a qualified electrician.

The minimum wire size for systems that require a 40A GFCI (Siemens or similar) is #8/3 conductor with ground. (also referred to as #8 gauge / 4 conductor).

The minimum wire size for systems that require a 50A or 60A GFCI (Siemens or similar) is #6/3 conductor with ground (also referred to a #6 gauge / 4 conductor).

SAFETY SIGN

Safety Sign Must Be Posted – The orange **WARNING** sign like the one shown is packed with your new spa/hot tub. This sign must be posted in a prominent place in close proximity to the spa installation site immediately upon completion of spa installation.



Important: It is extremely important that this sign be permanently placed in clear view of persons using the spa / hot tub. Occasional spa / hot tub users may not be aware of some of the dangers hot water poses to pregnant women, small children, seniors, and people under the influence of alcohol. If you did not receive a warning sign or your sign has become damaged, please call your local dealer for a replacement.

LOCATION AND INSTALLATION

Proper planning is an important consideration when installing your new spa / hot tub. Site selection is a critical step and requires serious thought. Planning ahead makes the installation process easier. The following information is provided to assist you in site preparation.

1. Always comply with local building codes and obtain any necessary permits. You may also need to consult with an engineer to address your specific design needs.
2. Contact an electrician to assess your electrical needs, install wiring, and assure a safe operation.
3. Position your spa / hot tub with proper access to water, drainage, and electricity.
4. Place your spa / hot tub on a uniform solid, flat surface designed to properly support its weight. For external installations, a 4-inch (10 cm) thick cement pad suffices.
5. For internal installations, check the load carrying capabilities of the floor on which the spa will reside. Most homes meet the requirement of 250 pounds per square foot.
6. Assure that your spa / hot tub will fit into the space you have chosen and the delivery route will accommodate its large size.
7. Provide adequate ventilation for the humidity created by your spa / hot tub. In most cases, the Color Coordinated Cover is sufficient.
8. Protect the pump and all equipment from the weather by ensuring the cabinet panels are secure at all times.
9. Allow 36 inches (1 meter) of unobstructed access to all sides of your spa / hot tub for normal servicing. Your spa / hot tub is not designed to be recessed in the ground or in a deck.
10. Consider positioning your spa / hot tub out of or adequately protecting it from the wind. Just as people can get cold on cool / windy days so can your spa / hot tub. Windy environments can significantly increase operating costs.
11. Consider using an insulating pad. In cold climates, the ground can rob heat from the spa / hot tub and increase your operating costs. Consider using a suitable, outdoor insulating pad in such environments.

Figure 1 – Espace requis (dégagement) et support



ELECTRICAL SPÉCIFICATIONS

Important: Qualified and licensed electricians must perform all electrical hookups. The following specifications must be followed in order to ensure proper performance and safety.

WARNING



Starting an incorrectly wired spa / hot tub could cause severe damage to the mechanical equipment or even bodily harm. Have your licensed electrician verify GFCI wiring with the schematics on pages 13-14 prior to starting the spa / hot tub or call your local dealer.

ATTENTION



Failure to abide by specifications listed may result in damage to the equipment and will void the warranty.
Test the GFCI before each use of the spa / hot tub.

All spa / hot tubs must be wired with a Siemens breaker (or according to IEEE wire regulations for export models). Failure to do so will cause equipment damage and will not be covered under your guarantee. All spa / hot tubs must be protected with an over current protective device with built-in GFCI in the service panel.

Tension (Volts)	Fréq (Hz)	Phase	Rating (A)	GFCI (A)	Wire size GFCI To main Panel*	# of terminals On plug
240	60	1	32	40	8-3, plus ground (less than 130')	4
240	60	1	40	50	8-3, plus ground less than 130') 6-3, ground more than 130'	4
240	60	1	48	60	6-3, plus ground	4

Tableau 1 – Wire Size Chart
Use 6AWG copper wire

WARNING



Disconnect the electrical power before servicing. Before obtaining access to terminals, all supply circuits must be disconnected.

Parts with extra low voltage (not exceeding 12V) must be inaccessible to a person in the spa / hot tub. Earthed appliances must be permanently connected to fixed wiring. Parts incorporating electrical components must be located or fixed so that they cannot fall into the spa / hot tub.

Means for disconnection must be used with fixed wiring configurations in accordance with local wiring rules.

IMPORTANT: To allow the GFCI to function properly, connect the white Neutral wire from the spa / hot tub to the Neutral terminal on the GFCI breaker, not the Neutral bus bar in the GFCI breaker box. An improperly connected Neutral causes the GFCI breaker to trip.

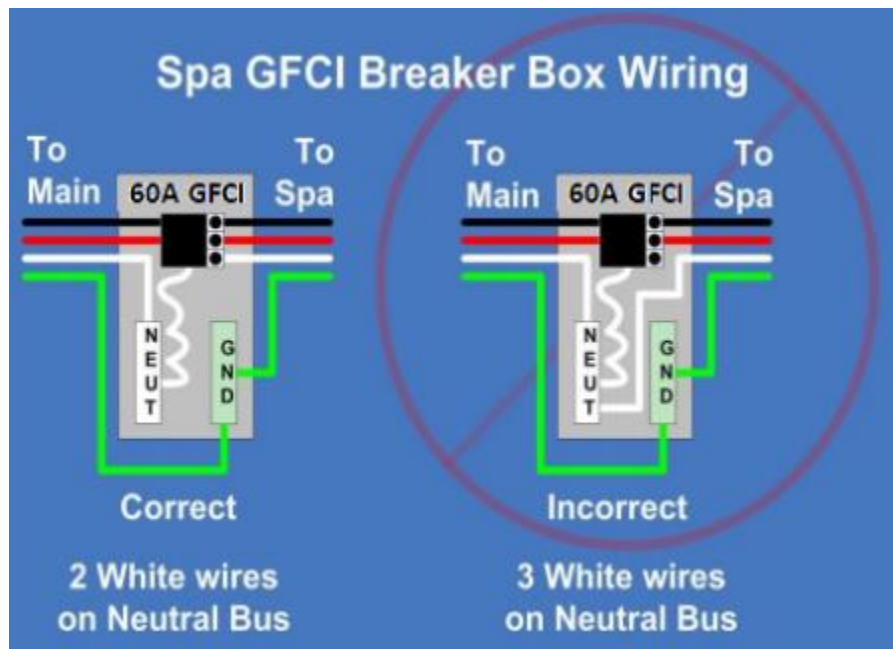

Figure 2 – GFCI Wiring

IMPORTANT: Use only a GFCI Circuit Breaker (Siemens or similar). Installation, including selection of conductor size and type, must be performed by a qualified electrician in accordance with the National Electrical Code or the Canadian Electrical Code, and all federal, state and local codes and regulations in effect at the time of installation.

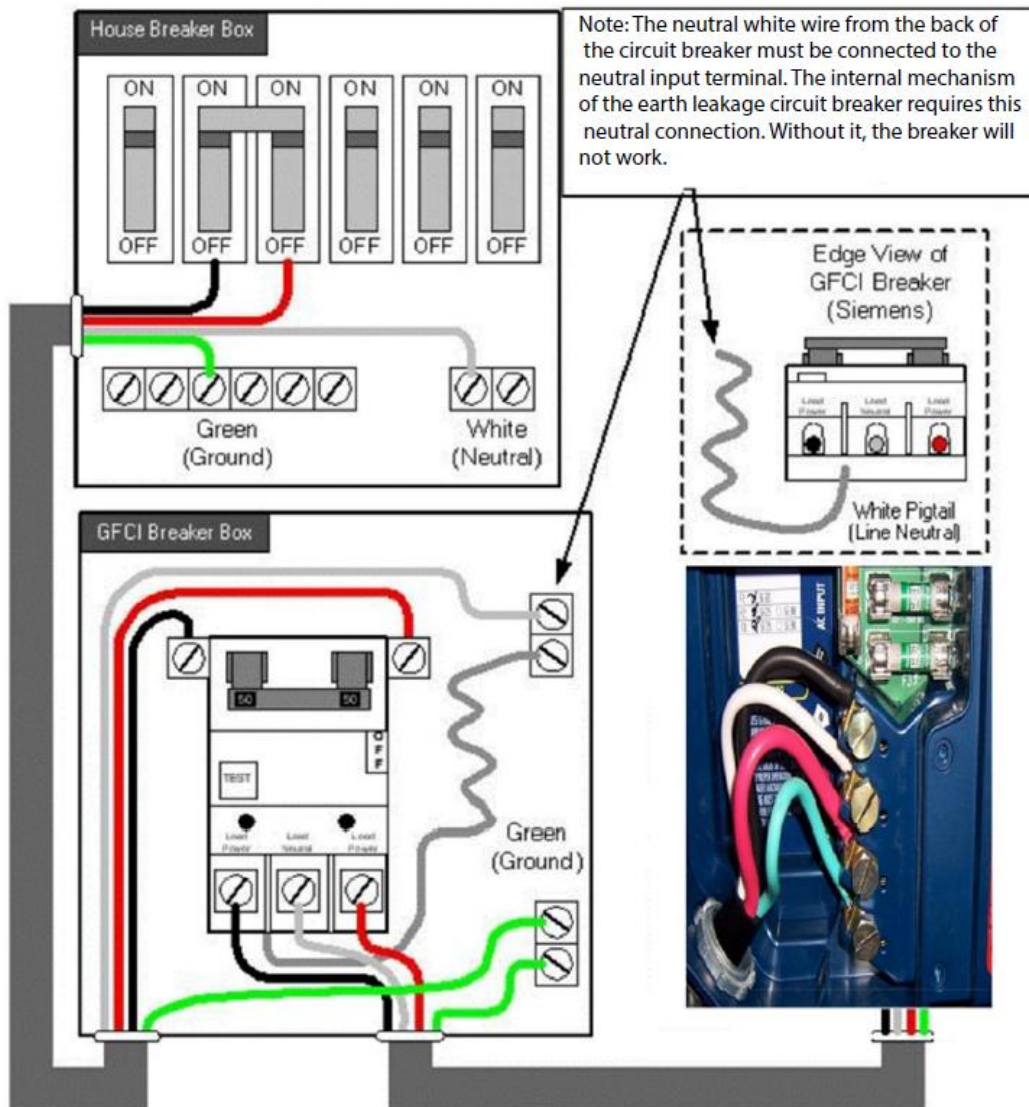

Figure 3 – Cable schematics
Consult the caliber chart page 11

SITE PREPARATION

ABOVE-GROUND INSTALLATIONS

Where the hot tub is a "stand-alone" above-ground installation to be installed in regions where freeze/thaw conditions may occur, a level patio stone or pre-formed paver type base may be sufficient if there is no abutting deck(s) that could be damaged during potential seasonal movement of the ground. The potential drawback to this type of base is that splash water could eventually de-stabilize the ground under the base, with the resultant shift of the support base causing damage to the hot tub structure.

For best results, we recommend the installation of a level concrete pad:

- **Dig out and level the ground 20-30 cm (8-12 in.) below your desired base level**
- **Install 10-15 cm (4-6 in.) of crushed stone**
- **Next, install 10-15 cm (4-6 in.) of poured concrete**
- **Level the concrete and apply a broom-type finish**
- **We recommend that the pad be made 15 cm (6 in.) larger than the hot tub on three sides, and 1 m (3 ft.) larger on the side where the access steps and/or planters will be installed.**
- **Hot tub/swimspa must be installed on a level pad**

In regions where freeze/thaw occurs, or where there will be custom decking abutting the hot tub we recommend the installation of sono-tubes beneath the pad to prevent shifting.

IN-GROUND & PARTIAL IN-GROUND INSTALLATIONS

For units being installed fully or partially in the ground, the type of support will again vary based on whether or not the tub is being installed in an area with freeze/thaw conditions. We don't recommend back-filling full in-ground or partial in-ground installations.

Non-freezing climates – it is sufficient to ensure that the base of the hole or cavity created for the tub has a dry, stable, compacted level base and proper drainage.

Climates where freeze/thaw occurs – it is necessary that a poured level reinforced concrete base, complete with concrete footings, be installed as outlined in the section **ABOVEGROUND INSTALLATIONS.**

Areas with a high ground water table – a level concrete base, as well as a concrete or wood retaining wall to hold back the earth, is recommended. This forms a box or 'bunker', in which the hot tub is placed.

ALWAYS ensure that there is good drainage, via a properly designed French drain (gravel) system and/or a sump pump, to prevent ground water flooding damage to the support equipment or hot tub structure.

Install protective waterproof conduit to house any cables that will be buried.

Access for future service must be considered at the time of design and installation. You must be able to access all sides and areas of your hot tub. Difficult access will result in supplemental service labor charges not covered by the factory warranty. Consider easily removable deck materials.

Make sure the hot tub or swim spa is tested for 48 hours before you prepare the installation of the surrounding/finish deck around your hot tub. Even though all units are tested in our plant, some transport/site handling damage can occur and we suggest you make sure the tub is perfectly waterproof before finalizing your installation.

FILLING

When adding water for the first time, the hot tub should be filled through the skimmer opening (helps to prevent air locks) using a standard garden hose, turning the tap on slowly to prevent damage to the surface by a jerking hose connection.

Fill the hot tub to the recommended level, approximately just under the pillow.

CHECKING

Although your hot tub was thoroughly water-tested in the factory, some loosening of fittings can occur during shipping. Before any decking, tiling or carpeting is completed around the installation, fill and operate your hot tub to test for leaks (this ensures easy access and inexpensive correction). Check all union connections and plumbing for minor leaks. In the event of a leak, ensure all union connections and pump plugs are tight and all O-rings/gaskets are in place.

STARTING

Before applying voltage to power-up your hot tub, it is very important that you understand the sequence of events that occur when the system is activated in order that the pump can be primed efficiently and damage to the system can be avoided.

Turn the main power "on" at your electrical panel.

Follow the control instructions for your particular model hot tub.

STARTING UP THE SPA

PROCEDURE - STARTING UP THE SPA

- 1** Remove and discard the Yellow clip;



- 2** Remove the cartridge;
Unlock the black top part following the direction of the padlock;

- 3** Put the disinfectant pebbles in the basket;



- 4** Lock the top part on the cartridge;
Put the cartridge back in its slot;

WARNING!



**NO FLOATER!
NO TRI-CHLOR!**

Tri-Chlor is very corrosive to the spa surface - above and below the water - and can affect pumps and jets.

Lucite.SPA | EasyCare.
Visit plaskolite.com for more information.

HOT TUB WATER BALANCE – GENERAL OVERVIEW

NOTABLE POINTS

The reliability and longevity of your hot tub support equipment are directly related to how well water quality is maintained!

The small volume of water in your hot tub is easily affected by the introduction of oils, lotions, perspiration and chemicals. It is imperative that you give your hot tub regular attention to maintain clean, safe and balanced water to prevent premature damage and/or failure (corrosion/calcification) to the support equipment.

Maintaining proper hot tub water balance and sanitizer levels is extremely important. Neglected hot water will allow bacteria to quickly spread.

The mineral content of hot tub water increases due to water evaporation, sanitizers and other chemicals. If the mineral concentration, particularly calcium, becomes too high, the minerals will literally “drop” or precipitate out of the water and deposit on the hot tub walls, plumbing, jets, in the filter and on the heater element.

It is very important that pH be checked frequently and maintained in the recommended range as indicated in the chart

WATER BALANCE SUMMARY FOR YOUR HOT TUB

It is also very important that Total Alkalinity (the ability of the water to resist a change in pH) be maintained in the recommended range as indicated in the chart **WATER BALANCE**

SUMMARY FOR YOUR HOT TUB

Although there may be two identical hot tub models right next door to each other, the maintenance requirements will be different, dependant on such factors as:

- ✓ bather load
- ✓ frequency of use/quantity of bathers
- ✓ different body chemistry
- ✓ sun vs. shade
- ✓ temperature

For these reasons, it is very important to develop proper hot tub water maintenance habits and follow your retailer’s recommended water maintenance procedures.

SAFETY INSTRUCTIONS FOR PRODUCTS



WARNING

CHEMICAL HANDLING SAFETY HINTS INITIAL WATER FILL & BALANCE

Never pre-mix chemicals with each other prior to adding to hot tub water.

Add only one chemical to the water at a time.

Always add chemicals to water and not vice-versa.

Chemicals may be corrosive, so handle with care and store in a cool dark place.

Never smoke near chemicals as most are flammable

Ensure any spilled chemicals are carefully cleaned up immediately.

Always have the POISON CONTROL telephone number handy in the event of an emergency.

Keep chemicals out of children 's reach

Wear safety glasses and gloves when handling chemicals.

INITIAL WATER FILL & BALANCE

1 Make sure the hot tub water is circulating and above 20°C (68°F)

2 Add a sequestrant (stain and scale controller). Allow water to circulate for an hour before adding anything else to the hot tub water.

3 Add a Shock / oxidizing agents.

4 Add sanitizing tablets (Bromine or Chlorine)

The ideal water level is right under the headrests.



It is important to check that there is always one cartridge in the skimmer and that it is well screwed.



WATER CHEMISTRY

DEFOAMER – removes foam build-up from the water surface. At best, this is a temporary remedy, as excessive foam is merely a symptom of improper water balance (typically high organic residue and/or high pH).

SEQUESTERANTS (STAIN AND SCALE CONTROLLERS) – keeps dissolved metals and minerals in the water from attacking the hot tub shell and support equipment components.

TOTAL ALKALINITY (TA) – the amount of carbonate, bicarbonate and hydroxide compounds present in the water that determines the ability or capacity of the water to resist change in pH. Also known as the 'buffering' capacity.

BROMAMINES – are formed when bromine destroys nitrogen-bearing organic matter. Unlike chloramines, bromamines don't cause eye irritation, however, when allowed to go unchecked, will cause an objectionable odour.

TWO-PART BROMINE – composed of a liquid or powder component introduced manually into the water on a weekly basis, and a granular component that is added daily or as the hot tub is used.

ONE-PART BROMINE – also available in puck/tablet form, is another type of oxidant/biocidal agent, and is introduced into the hot tub water via a brominator. Recommended bromine residual level is 3.0 to 5.0 ppm

CHLORINE – in granular, liquid or puck/tablet form, is an oxidant and biocidal agent. It is very effective and fast acting. Recommended chlorine residual level is 3.0 to 5.0 ppm.

CHLORAMINES – a compound formed when chlorine combines with nitrogen or ammonia present in the water. When allowed to go unchecked, it causes eye and skin irritation and is indicated by a strong chlorine odor.

SHOCK – the practice of adding an oxidizing agent to hot tub water to destroy ammonia, nitrogenous and organic contaminants (chloramines and bromamines).

CALCIUM HARDNESS – the calcium portion of the total alkalinity which represents 70 to 75% of total hardness. Calcium concentrations determine whether water is 'soft' - too little calcium, or 'hard' -too much calcium.

TOTAL DISSOLVED SOLIDS (TDS) – a measure of the total amount of dissolved matter in the water (calcium, carbonates, bicarbonates, magnesium, metallic compounds, etc.)

PPM – abbreviation for 'parts per million', the unit of measurement used in chemical testing which indicates the parts by weight in relation to one million parts by weight of water. Essentially identical to the term mg/L - milligrams per liter.

CARTRIDGE FILTER CLEANER – degreases and cleans cartridge filters.

OZONATOR – generates Ozone (a gaseous molecule composed of 3 atoms of oxygen) and is injected into the hot tub water for the oxidation of water contaminants.

pH – a logarithmic value expressing the relative acidity or basicity of a substance (such as hot tub water) as indicated by the hydrogen ion concentration. pH is expressed as a number on a scale of 0 to 14, where 0 is most acidic, 1 to 7 being acidic, 7 considered neutral, 7 to 14 being basic, and 14 being most basic. The ideal range for hot tub water is 7.4 to 7.6 ppm

pH DECREASER – lowers the pH level of the water.

ALKALINITY BOOSTER – raises the alkalinity.

SOLUTION DE HAUSSE DU CALCIUM – hausse le niveau de calcium.

pH INCREASER – raises the pH level of the water.

TEST KIT – used to monitor specific chemical residual or demands in the water. May be in the form of litmus strips or liquid drops.

SANITIZER (ppm)	MIN	IDEAL	MAX
Chlorine	1.0	3.0 - 5.0	5.0
Bromine	2.0	6.0 - 10.0	10.0
CHEMICAL			
PH	7.2	7.4 - 7.6	7.8
Total Alkalinity (TA)	80	80 - 120	180
Calcium Hardness	150	200 - 400	500 -1000

WATER BALANCE SUMMARY FOR YOUR HOT TUB*

***National Spa & Pool Institute recommended levels for residential spas/hot tubs**

CONTROL ACCESSORIES

Air venturi jet

The PARTY spa is equipped with one (1) or more VENTURI jets.

These settings jets will allow you to control the flow of water or air delivered by your nozzles.

The toning massages provided by the venturi jets allow a fast and lasting relaxation of the muscles

Divatar valve

The PARTY spas are equipped with a 3-way valve that can control 1 seat up to 7 seats. The three (3) valve lets you share your jets in each seat. Reversing the flow of water is possible at the deviation chute installed in your spa.

Waterfall control

The controller has an ON and OFF position. When you turn the joystick to ON, the waterfall will start working.

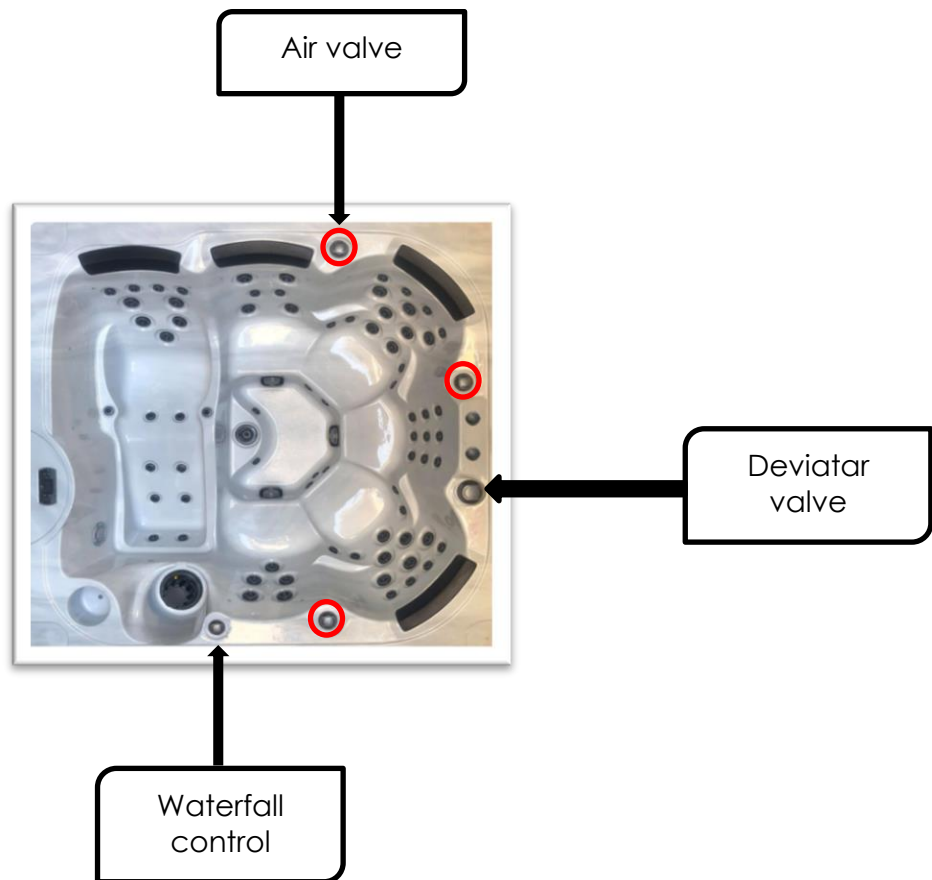

WATER BALANCE TROUBLESHOOTING

PROBLEMS	POSSIBLE CAUSES	SOLUTIONS
Cloudy water	Dirty filters Microscopic particles too small to filter Too old water	Clean the filters. Test and adjust all water balance elements and add flocculent to cause the particles to combine together so they can be filtered out. Increase filter cycle time. Empty the spa and refill it.
Smelly water	Excessive presence of organic matter in the water	Shock the spa water with a disinfectant and adjust the pH. If the problem persists, empty, clean and fill the spa.
Tinted water	Copper, iron or other dissolved metals from the water source or equipment	Add an algicide
Algae formation	PH level too high Level of disinfectant insufficient	Shock the spa water with a disinfectant and adjust the pH. Shock the spa water with a disinfectant and maintain the level of disinfectant.
Eye / skin irritation	pH too low	Add a pH Booster until level is 7.2 - 7.6
Excessive Foam	Buildup of body oils or cosmetics	If no water line is present you can try using defoamer to break up the contaminants and then a clarifier* to help filter them away. If a water line is present the spa may need to be drained and cleaned. Either way, the filter should be thoroughly cleaned by soaking over night in bleach. An oil absorbing sponge can help in preventing this in the future. Increase filter cycle time.
Organic / moldy accumulation around the spa	Accumulation of oil and dust	Wipe the foam with a clean cloth. If necessary empty the spa, use a spa surface cleaner to remove foam and refill the spa.
Corrosion/Etching	Presence of metals in water (iron, copper, ...)	Test total alkalinity levels and if necessary increase with sodium bicarbonate.
Discoloured Water (Clear v. turbid water)	Presence of metals in water (iron, copper, ...)	Treat with chelating or sequestering agent.
Unstable pH	Low Total Alkalinity levels	Test total alkalinity levels and if necessary increase with sodium bicarbonate
pH resistant to changing	High Total Alkalinity levels	Test total alkalinity levels and if necessary decrease with sodium bisulfate or muriatic acid.

ROUTINE HOT TUB MAINTENANCE

Tip: Check with your insurer that your spa is an insurable.

REVIEW CHEMICAL HANDLING SAFETY HINTS DAILY

EVERY DAY OR AT LEAST 3 TIMES A WEEK

- 1 Test water, and if necessary, add shock.
- 2 Ensure proper water level is maintained.

WEEKLY

- 1 Test pH and Alkalinity. Adjust accordingly
- 2 Top-up chemical dispenser
- 3 Add sequesterant (stain and scale controller)
- 4 Remove and spray cartridge filter with garden hose and reinstall
- 5 Add Shock / oxidizing agent

MONTHLY

Soak your filter cartridge in a filter cartridge cleaning solution. Rinse thoroughly and, if possible, allow to dry before re-installing.

QUARTERLY

Drain hot tub at least once per quarter and clean the acrylic shell surface with a non-abrasive cleaner designed specifically for acrylic surfaces.

CHANGING THE HOT TUB WATER

A hot tub should be drained every 8-12 weeks, depending on size and amount of use. If your hot tub is used daily or by a large number of bathers, the water should be drained more often. One method to determine the approximate length of time between water changes is to divide the water volume (in liters) of your hot tub by 13.5 and then divide by the average number of bathers each day.

COVER

When the spa is not in use, it must be covered by its cover which is to be locked, in order to render the spa safe and keep the heat of the water.

CLOSING PROCEDURE

If you choose not to use your spa during the winter, you must continue to maintain it until closing. Keeping the water clean longer helps to minimize dirt build-up and bacteria formation and thus avoid any risk of possible contamination.

To protect the equipment from frost and keep the water clear, never stop the filtration system before closing the spa.

Procedure

1. First, operate the pumps and pour two (2) cups of bleach into the spa. Run the pumps for 1 hour (restart them when they go out).
2. Disconnect power from the spa.
3. Drain the spa using one of the following methods: By gravity, using the drain hose or with a submersible pump.
4. Remove the cartridge (s) from the skimmer and rinse with clean water. Soak them in the cleaning product. Rinse them and let them air dry.
5. Store them for the winter. If they are no longer good, please take the information on the cartridge, such as the size, and take pictures of them before throwing them away.
6. Remove all adjustable jets.
7. Leave the head restraints in place. Clean the shell with an acrylic cleaner.
8. Make sure that the guillotine valves on each side of the heating element and in front of the pumps are open.

If you have an In.Clear system in the spa, see the cleaning section in the In Clear manual.

Drainage of piping

You must use a vacuum cleaner or blower to close properly. Blow into all the hoses to properly drain the jets. You must do it at least 2 times for each pipe. Vacuum the remaining water at the bottom of the spa with the vacuum cleaner.

Valves of waterfalls and throws

Unscrew the on / off valves and remove the o-rings and the pivot. Blow into the valves using the cone of the blower until all the water has come out of the falls and neck throws. Reinstall o-rings, taking care to lubricate them. Close the valve. Vacuum the remaining water at the bottom of the spa with the vacuum cleaner. Vacuum the drain drain from the spa for about 1 to 2 minutes. Vacuum each body of jets at least twice with the vacuum cleaner. Aspirate skimmer orifices and drains. Do not forget to put the skirt panels back in place and screw them tight.

Close the circuit breaker outside (GFCI or DCI) and inside the house (electrical panel). Dry the hull. Pour non-toxic antifreeze into each hole of the skimmer until the antifreeze exits through the drains inside the spa. Add 1/2 cup of non-toxic antifreeze in each of the jets. Clean the spa cover with the cover cleaner and let it dry. Place the lid on the top of the spa. You can cover the spa with a polyethylene canvas and make sure everything is well fastened to face the winter. Leave space between the fabric and the spa skirt to prevent moisture build-up.

KEYPAD IN. K500 (910)

in.k500 keypad layout

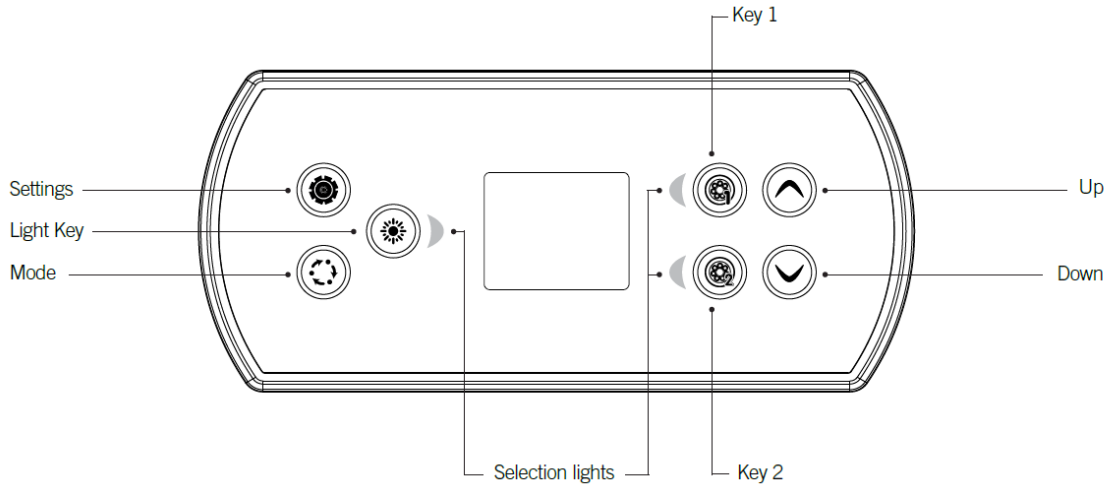

**Functions for keys 1 and 2 will depend on your system's low level configuration.*

Settings key

One press gives you access to a menu to manage the settings of your spa. Refer to the settings section for details about the settings menu.

Mode key

Successive presses on the Mode key will give access to control different optional accessories of your spa such as Audio and others. Note that if an accessory is not present in your spa configuration, its menu will not appear. Refer to the following section to get details about the possible accessories and their detailed functionalities. The screen will revert back to the spa mode if no key is pressed for 60 seconds.

If you don't have any accessories on your spa, the Mode key can be used to directly change your display orientation.



Power

Press any button to turn the keypad on. After 30 minutes without activity it will shut off.

Main screen

The main screen gives you access to your accessories and water temperature. At the bottom of the screen you will see any error or maintenance messages that are present.



Start or stop accessories

To start or stop an accessory, press the associated button. Icons will become animated when their accessory is turned on, and inanimate when turned off. Icons on the screen will reflect the speed or state of the devices running on your spa.

When an accessory has more than two states, press the button until it reaches the desired state.

Note (version 14.00 and higher):

A special buttons and icons mapping may be used when the spa configuration has 4 accessories* (3 pumps and a blower or 4 pumps and no blower). In this case only, buttons and icons are divided in 2 sets of accessories.

Button #1 starts or stops pump #1 and pump #2.

Button #2 starts or stops Pump #3 and Pump #4/blower.

Corresponding icons will be animated when one or more accessories are on.

* Only Pump #1 can have a dual speed.



Water temperature

The temperature shown at the top of the screen is the current water temperature. Use the Up and Down buttons to set the desired temperature.

The set point will appear in blue at the bottom.

After 3 seconds without any change to the set temperature value, the keypad will resume the normal display of messages.

When the set value is lower than the current temperature *Cooling to xx.x* will appear. When the set value is higher than the current temperature, *Heating to xx.x* will be indicated. Normally there is a short delay before the heating starts, during which *Heating Suspended* is indicated.



Settings

From the home page you can access the *Settings*, where you will find:

- *Water care*
- *Audio (if installed)*
- *in.clear-200 linked version*
- *Standby*
- *Maintenance*
- *Date & time*
- *Keypad*
- *Wi-Fi*
- *Config*
- *Restore*
- *About*

Use the arrow keys to move up and down in the list. To select an option, press the lit button beside it (Light button).

At any point you can press the Settings button to return to the home screen.



Water care

The Water Care section will help you set up your ideal filtration and heating settings. Choose from *Away*, *Beginner*, *Energy Savings*, *Super Energy Savings*, and *Weekender*, depending on your need. Use Light key to choose your setting. A checkmark will appear on the selected icon to confirm.

In Economy mode, the set point will be reduced by 20°F*, which means that the heating system will not be engaged unless the temperature falls to 20°F below the spa's set temperature.

* *Default pack value*

Water care modes



Away:

In this mode the spa will always be in economy; the set point will be reduced by 20° F*.



Beginner:

The spa will never be in economy mode and will be filtering according to the pack's low level configuration.



Energy Savings:

The spa will be in economy mode during the peak hours of the day and resume normal mode on the weekend*.



Super Energy Savings:

The spa will always be in economy mode during peak hours, every day of the week*.



Weekender:

The spa will be in economy mode from Monday to Friday, and will run normally on the weekend*.

**Filtration will be reduced when the economy mode is active.*



Modifying schedules

To see and/or modify a Water Care category, use the lit button to the right (Key 1) to open the selected Water Care menu.

Use the arrow keys to choose a schedule to modify (choice of economy and filtration schedules). Use the Light key to move between parameters.

You have several possibilities for the schedule (Mon-Fri, weekend, every day, or single days). The schedules will be repeated every week. The time and duration are set in 30 minute increments. Once you have set the schedule, use Key 1 to go back. Ensure that you have selected the desired Water Care option in the main Water Care menu.



The filtration schedule shown on the screen will apply to the main filtration pump, most likely pump 1. If your spa uses a circulation pump configured to run 24 hours, the screen will show you the purge setting instead of filtration. The purges are pre-programmed for a fixed number of minutes, therefore the duration will be set to N/A on the screen, and only the start time can be modified.



Maintenance

From the Settings page you can access the Maintenance menu, which gives you access to the following options:

- *Maintenance reminders*
- *Standby*

Use the Up and Down keys to make a selection, and Light key to confirm.



Maintenance reminders

The in.k500 keypad will remind you of maintenance required on your spa, like rinsing or cleaning the filter. Each task has its own duration, based on normal use.

The Maintenance reminders menu allows you to verify the time left before maintenance is required, as well as to reset the time once a task is completed.

Use the Up and Down keys to move through the list.

To reset a task select it by pressing Light key, then confirm when prompted. Once you have confirmed the task will be reset.



Standby

The Standby mode allows you to service your spa. Pumps will stop for 30 minutes, and automatically restart after this time.

Once Standby mode has been activated a screen will appear to show that pumps are stopped. The normal spa page will return at the end of maintenance.

Press the Key 1 to leave Standby mode and restart the spa.

Note:

In version 6.00 only, Standby mode is accessible directly from the Settings page.



Date and time

Here you can adjust the time format, change the year, date and time. Use the arrows to choose the setting that you want to adjust, and select it by pressing the Light key.

Use the arrow buttons to change the parameters, and the Light key to move between parameters. Key 1 will take you back to the main Settings menu.

Note:

In version 6.00 and earlier, only the day of the week can be changed, and not the year or date.



Keypad settings

In this section, you can change the temperature unit, language, display orientation, rim light color and keypad security. Note the spa pack must be configured accordingly to be able to change the rim light color.

When you change the display orientation, the contextual options and arrow keys adjust to the chosen orientation. If you don't have any accessories installed on your spa, the Mode key can be used as a display orientation key. Simply press on it to change your orientation from normal to inverted, and vice versa.

Whether the display is inverted or not, the Mode and Menu keys remain unchanged, as well as the accessory keys in the main Spa menu.

With the in.k500 equipped with a selectable rim light color modul: If the "RGB backlight" option is enabled in the spa configuration an option will appear to allow selection of the keypad rim light color.



You can lock the keypad by selecting one of 3 security levels: Unlock, Partial or Full. The Partial level locks the set point adjustment and many options in the settings menu. The Full level locks all keypad functions. To unlock the keypad (either Partial or Full), press and hold the top right key for 5 seconds.

AUDIO IN.K500 (OPTIONAL 910)

WEB SITE FOR MORE INFO : <https://geckokeypads.com/k500use>

in.stream 2 operation



Press the **Mode** key to access your in.stream 2.

If you are using a device with Bluetooth technology, it must be connected for functions to work.

Play/Pause audio

Press the Play/Pause button to start or pause the audio. This button is available for Bluetooth and USB only.

Adjusting the volume

Press the Up or the Down key to increase or decrease the volume.

Turn power On/Off

This option can be found under the Audio section in the Settings menu.

Changing tracks

Use the Last Track and Next Track keys to change tracks or FM stations. This is not available with Aux source.

Disconnect

This option can be found under the Audio section in the Settings menu.

Fader, Balance and Subwoofer

These options can be found under the Audio section in the Settings menu.



WiFi

For the WiFi menu to appear in the Settings menu your in.touch module must be equipped with software version 11.00 or higher. This menu allows you to connect your in.touch module to a WiFi network or to change its network.

For more details about other in.touch connection methods please see the in.touch techbook.

To connect your in.touch module to a wireless network, use the Up/Down keys to go to the WiFi option in the Settings menu and Light key to select it.



After a few seconds the available networks will appear on the screen, as well as their signal strength.

Use the Up/Down keys to move through the list. Select your network by pressing on Light key.

If the WiFi network is password protected enter it when prompted.

- Use the arrow keys to choose your letters and change the type of character (uppercase, lowercase, number, symbol).
- Use Key 2 to move the cursor forward
- Use Key 1 to backspace
- Use Light key to confirm

If no password is required the in.touch will connect automatically.



Once the in.touch module is connected to a WiFi network a check mark in a green circle will appear in the WiFi menu, and the network logo will change to green in Settings menu.

Note:

WiFi logo color in Settings menu corresponds to the in.touch connection state.

Yellow = not connected

Green = connected to a network

Yellow with wait icon = connection attempt to a network

Red with wait icon = in.touch no longer detected

(in.touch must be reset before next connection attempt)

KEYPAD IN. K1000 (920)

WEB SITE FOR MORE INFO : <https://geckokeypads.com/k1000settings>

in.k1000 keypad layout

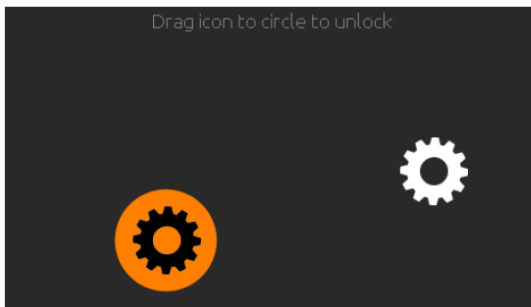

Sleep mode

Touch the screen to exit sleep mode. 3 minutes after the last pump is turned off, the screen will shut off if there is no touch activity.

Then Follow the instructions on the screen to access the main screen.

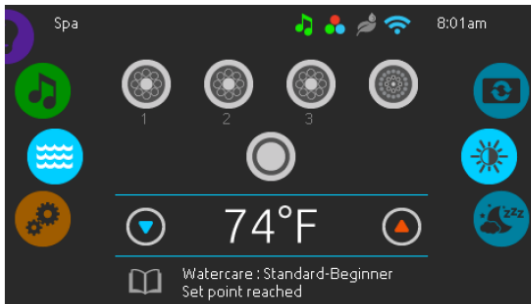

Main screen

The main screen gives you access to your accessories and water temperature. At the bottom of the screen you will see any error or maintenance messages that are present.

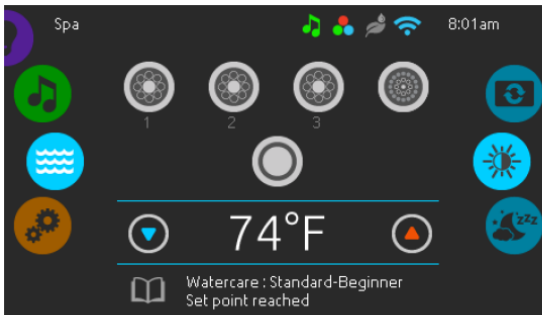
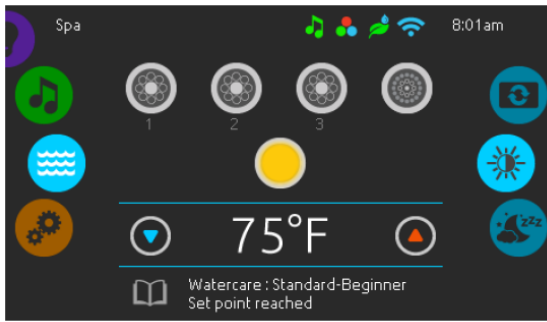

Start or stop accessories

To start or stop an accessory, touch the associated icon. Icons will become animated when their accessory is turned on and animation will stop when turned off. Icons on the screen will reflect the speed or state of the devices running on your spa. When an accessory has more than one speed press the button until it reaches the desired speed.

Notifications

A notification area at the top right-hand side of the screen shows the state of certain installed accessories.

Notification icons

in.touch:

- Indicates that the in.touch module is detected and connected to a Wi-Fi network.
- A red cross indicates that the in.touch module is detected but is not connected to a Wi-Fi network.
- An animated icon indicates that the in.touch module is connecting to a Wi-Fi network.

For more information about the in.touch, refer to the Wi-Fi section.

in.clear:

- The icon is green when the in.clear is generating bromine.
- The icon is grey when the in.clear is not generating bromine.
- A red cross indicates that the in.clear is turned off.

For more information about the in.clear, refer to the in.clear functions section.

in.stream 2:

- The icon is green when the in.stream 2 is on.
- A red cross indicates that the in.stream 2 is turned off.

For more information about the in.stream 2, refer to the in.stream 2 functions section.

in.mix:

- Indicates that an in.mix system is detected.

For more information about the in.mix system, refer to the in.mix functions section.

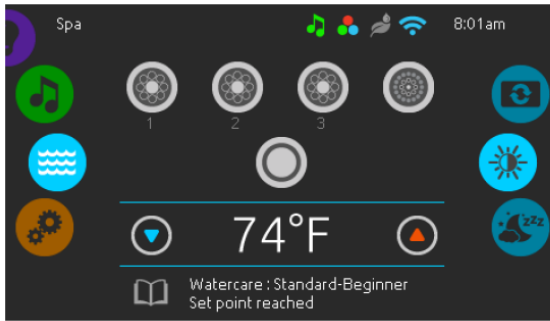

Water temperature

The temperature shown at the bottom of the screen indicates the current water temperature. Use the Up and Down icons to set the desired temperature. The set point will appear in blue. After 3 seconds without any change to the set temperature value the current water temperature will reappear in white.

When the set value is lower than the current temperature *Cooling to xx.x* will appear below. When the set value is higher than the current temperature, *Heating to xx.x* will be indicated under the value.

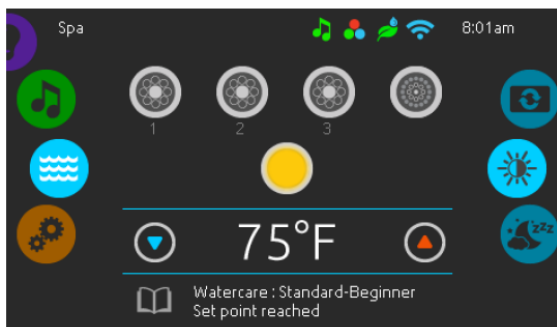

Spa menu

From the home page you can access the following:

- *in.clear (if installed)*
- *in.stream 2 (if installed)*
- *in.mix (if installed)*
- *Spa menu*
- *Settings*

To select an option, slide the left wheel up or down until the desired icon menu is highlighted in the middle.

On the right side is a menu for access to the Display and Contrast pages.

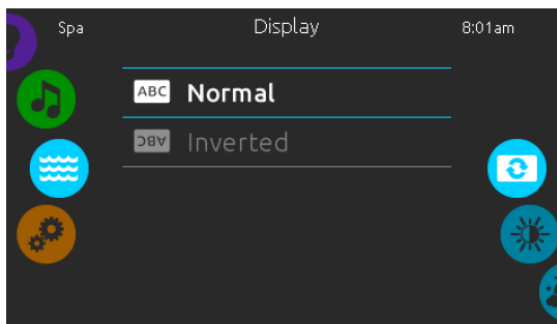

Display page

Use this page to change the display orientation.

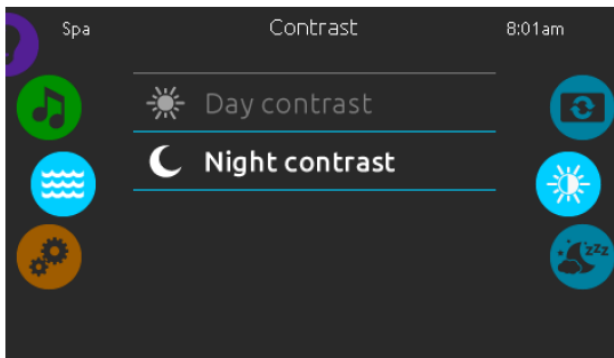

Contrast page

Use this page to change the display contrast.

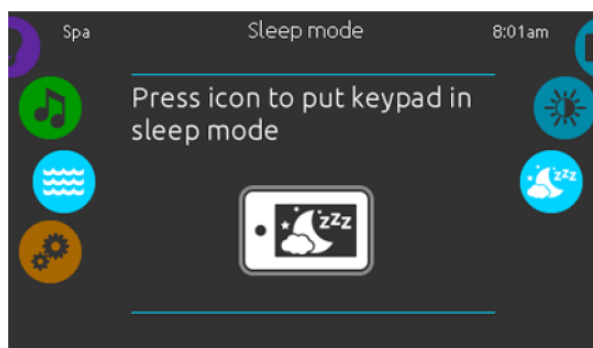

Sleep

Press key to go directly into the sleep mode. In sleep mode, water splashing on the keypad can't inadvertently start/stop a pump.

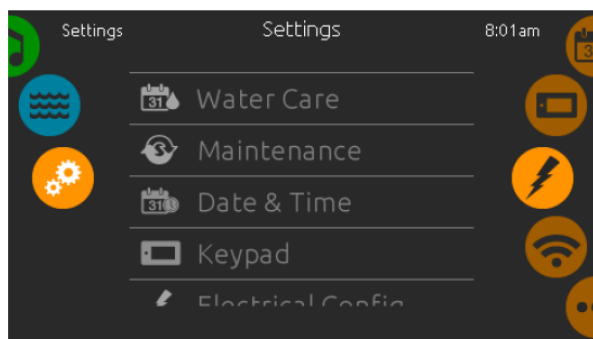

Settings

In the Settings page you can access the following:

- *WaterCare*
- *Maintenance*
- *Date & Time*
- *Keypad*
- *Electrical Config*
- *Wi-Fi*
- *Miscellaneous*
- *About*

To select an item, slide the right wheel until the desired icon is highlighted in the middle or press on the menu name.

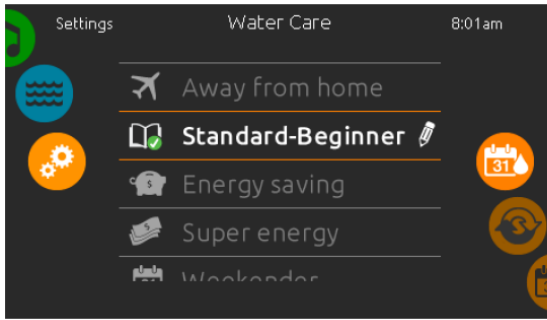

Water Care

The Water Care page will help you set up your ideal filtration and heating settings. Choose between *Away from Home*, *Standard-Beginner*, *Energy Savings*, *Super Energy* and *Weekender*, depending on your need. Touch the Water Care name to choose your setting. A green checkmark will appear on the selected icon to confirm your choice.

When you select another water care setting, a confirmation window appears to prevent inadvertent selection that could result in a setup modification for your spa.

In Economy mode, the set point will be reduced by 20°F*, which means that the heating system will not be engaged unless the temperature falls to 20°F below the spa's set temperature.

The filtration schedule shown on the in.k1000 screen will apply to the main filtration pump, most likely pump 1. If your spa uses a circulation pump configured to run 24 hours, the screen will show you the purge setting instead of filtration. The purges are pre-programmed for a fixed number of minutes, therefore the duration will be set to N/A on the screen and only the start time can be modified.

* Default pack value

Water care modes



Away:

In this mode the spa will always be in economy; the set point will be reduced by 20° F.



Standard-Beginner:

The spa will never be in economy mode and will be filtering according to the pack's low level configuration.



Energy Savings:

The spa will be in economy mode during the peak hours of the day and resume normal mode on the weekend.



Super Energy Savings:

The spa will always be in economy mode during peak hours, every day of the week.



Weekender:

The spa will be in economy mode from Monday to Friday, and will run normally on the weekend.

modifying water care schedules



water care

To modify a Water care category, touch the pen icon at the right end of the desired water care to open the selected Water Care menu.

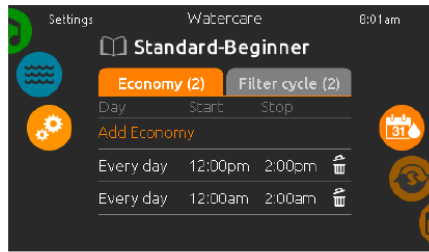

economy

Touch the Economy tab to change the economy schedule. You can add economy schedules by touching the orange line labeled "Add Economy".

To delete a schedule, touch the garbage can icon at the right end of the desired line.

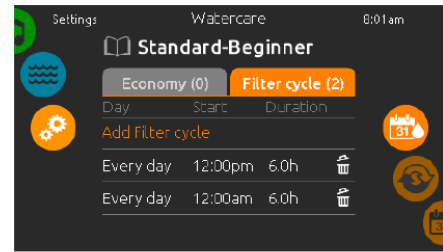

filter cycles

Touch the Filter cycle tab to change the filter cycle schedules. You can add filtration schedules by touching the orange line labeled "Add filter cycle".

To delete a schedule, touch the garbage can icon at the right end of the desired line.

In Economy mode, the set point will be reduced by 20°F, which means that the heating system will not be engaged unless the temperature falls to 20°F below the spa's set temperature.

The filtration schedule show on the screen will be applied to the main filtration pump, most likely pump 1. If your spa uses a circulation pump configured to run 24 hours, the screen will show you the purge setting instead of filtration.

The purges are pre-programmed for a fix number of minutes, therefore the duration will be set to N/A on the screen, and only the start time can be modified.

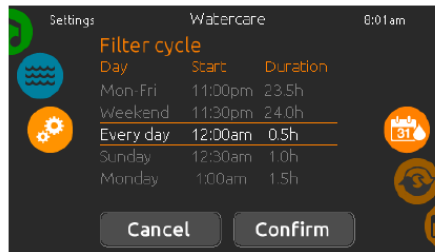

You can modify the programmed schedules by selecting one and adjusting the schedule.

You have several possibilities for the schedule (Mon-Fri, weekend, every day, or single days). The schedules will be repeated every week. The time and duration are set in 30 minute increments.

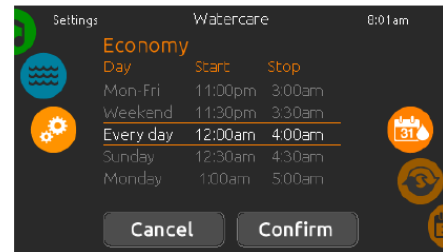

Once you have set the schedule, press "Confirm". If you don't want to keep any changes, press "Cancel" or use the calendar icon to go back.

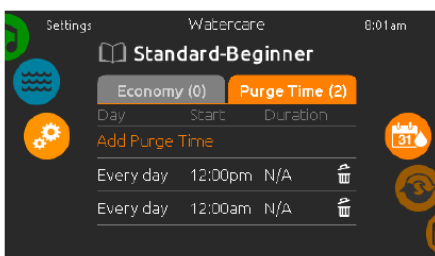

purges

Touch the Purge tab to change the purge settings. You can add purges by touching the orange line labelled "Add purge time".

To delete a schedule, touch the garbage can icon at the right end of the desired line.

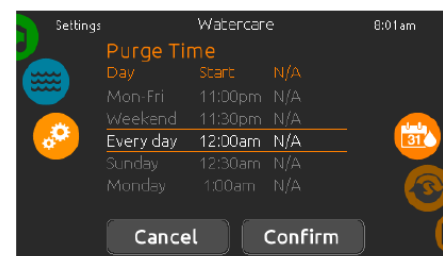

You can modify the programmed purges by selecting one and adjusting the schedule.

You have several possibilities for the schedule (Mon-Fri, weekend, every day, or single days). The schedules will be repeated every week. The time and duration are set in 30 minute increments. Once you have set the purge, press "Confirm". If you don't want to keep changes, press "Cancel" or the calendar icon.

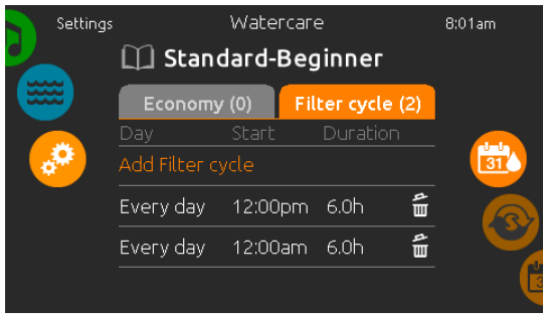

Modifying schedules

To modify a Water Care category, touch the pen icon at the right end of the desired Water Care to open the selected Water Care menu.

Touch the Economy tab to change the economy setting and Filter cycle tab for the filtration settings (or schedules). You can add economy or filtration schedules by touching the orange line labelled « Add Filter cycle » or "Add Economy cycle".

To delete a schedule, touch the garbage can icon at the right end of the desired line. Confirm your action when prompted.

You can modify the programmed schedules by selecting one and adjusting the schedule.

You have several possibilities for the schedule (Mon-Fri, weekend, every day, or single days). The schedules will be repeated every week. The time and duration are set in 30 minute increments. When changes are done, press "confirm". If you don't want to keep any changes, press "cancel" or use the calendar icon to go back. Ensure that you have selected the desired Water Care mode in the main Water Care menu.

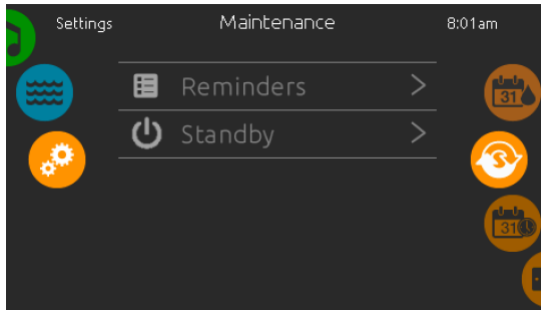
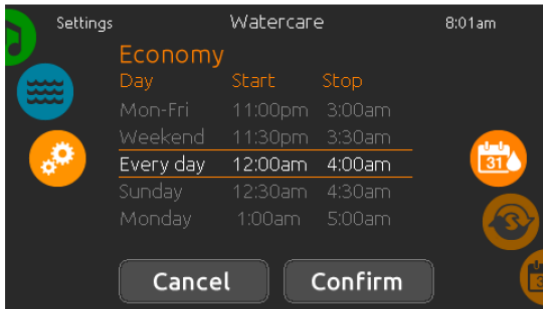

Maintenance

From the Maintenance page you can access the following:

- *Reminders*
- *Standby*

To access the desired option simply touch the corresponding menu item.

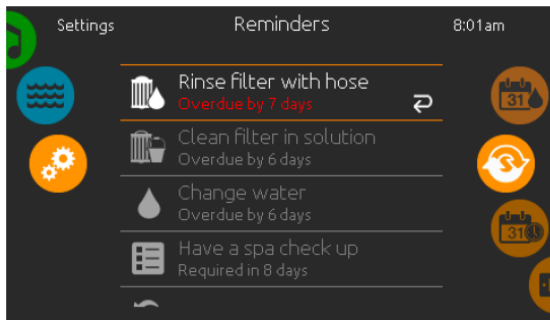

Reminders

The in.k1000 keypad will provide reminders about maintenance required on your spa, like rinsing or cleaning the filter. Every task has its own duration based on normal use.

The Reminders menu allows you to check the time left before maintenance is required, as well as to reset the time once a task has been completed.

To reset a task, select it by pressing the curved arrow, then confirm when prompted. Once you have confirmed, the task will be reset.

You can also use the option *Reset Reminders* to reset all the reminders.

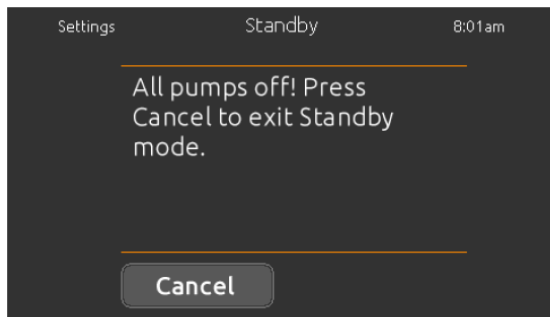

Standby

The Standby mode allows you to service your spa. Pumps will stop for 30 minutes and will automatically restart after.

The normal page will return at the end, once the pumps will be restarted.

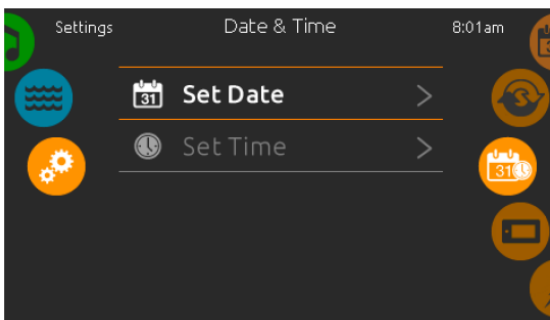

Date and Time

Use this page to change Date/Time settings.



Set date

Here you can adjust the year, month and day.

Simply swipe up and down the column you want to change and select the desired value. When you are done, touch the calendar icon at the right of the screen.

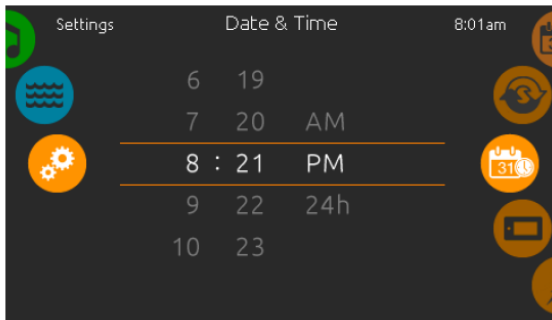

Set time

Here you can change the hour, minute and time format.

Simply swipe up and down the column you want to change and select the desired value. When done, touch the calendar icon at the right of the screen.

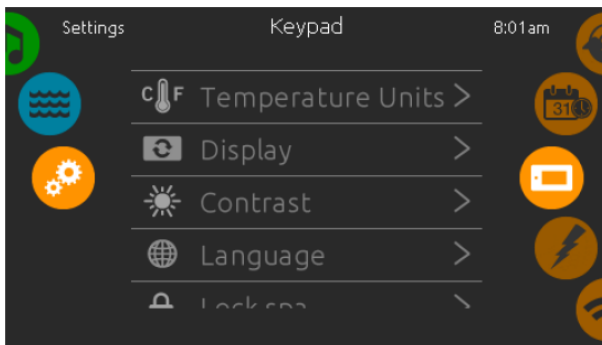

Keypad settings

In the keypads page you can access the following:

- *Temperature units*
- *Display*
- *Contrast*
- *Language*
- *Lock spa (optional)*
- *Keypad color (optional)*

To select an item, slide the right wheel until the desired icon is highlighted in the middle or press on the menu name.

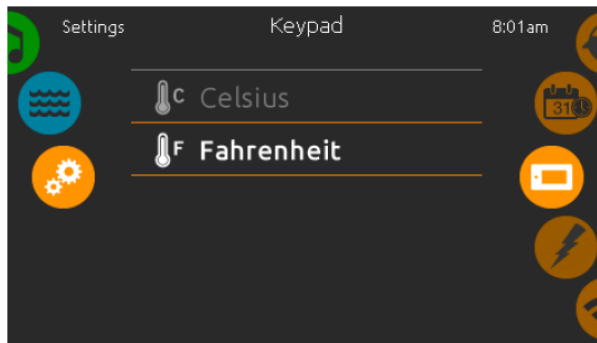

Temperature units

Choose the desired units to display temperatures.

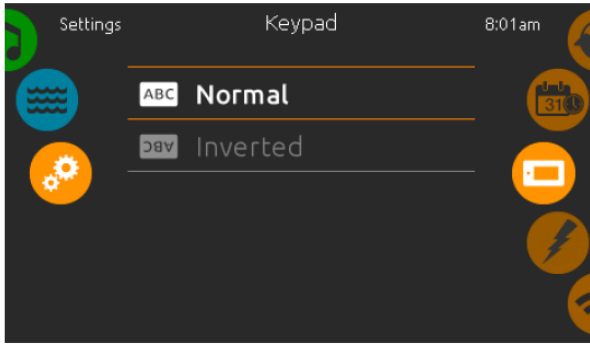

Display page

Use this page to change the display orientation.

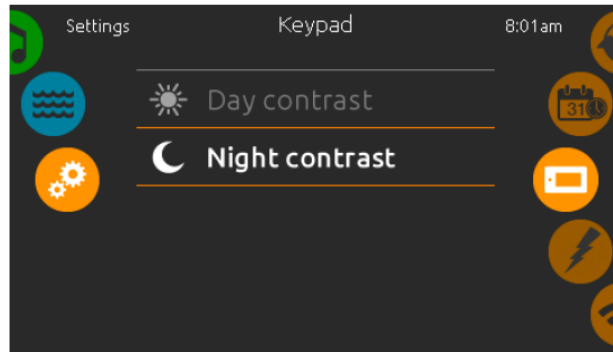

Contrast page

Use this page to change the keypad contrast.

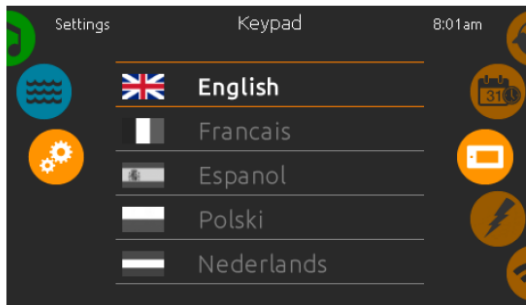

Language select

Use this page to select the display language of the in.k1000 keypad.

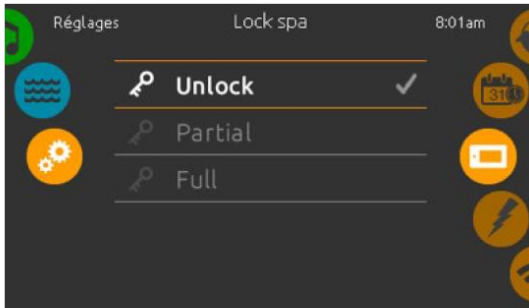

Keypad lock/unlock (optional)

When this option is enabled, the user can partially or completely lock the keypad. When the user wants to lock the keypad he is asked to select a 4-digit code. The same code will be needed to unlock the keypad. Next time he wants to lock the keypad, he will be prompted again to select a 4-digit code (same functionality as a Safe in a hotel room).

The keypad can be unlocked with a universal unlock code (3732) or by a reset of the keypad.

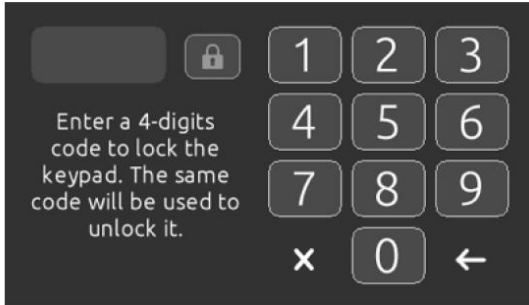

When Full Lock is selected, all functions are locked.

In Partial Lock, you may only activate accessories. Settings may not be changed in this mode.

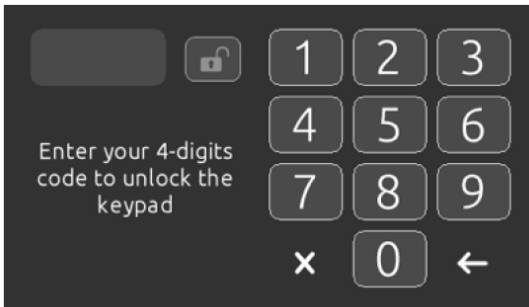

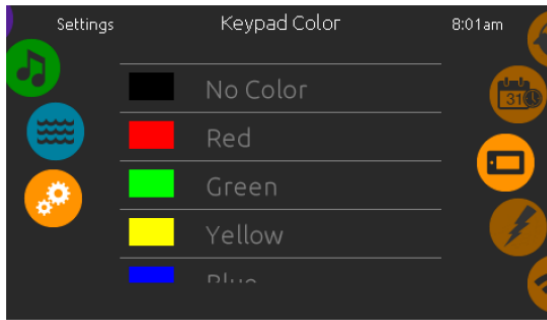

Keypad Color (optional)

If this option is available (depending on the spa configuration), the keypad rim color can be changed. 8 pre-defined colors are available. If the in.mix is installed, the keypad rim color can also be associated to an in.mix zone.

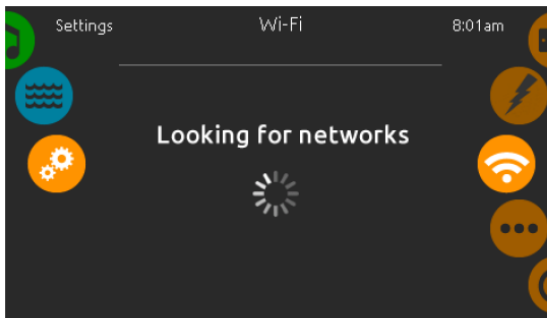

Wi-Fi (in.touch)

This page allows you to connect your in.touch module to a Wi-Fi network or to change its network.

For more details about other in.touch connection methods, please see the in.touch techbook.

After a few seconds the available networks will appear on the screen, as well as their signal strength.

Swipe Up or Down the list to select your network.

If the Wi-Fi network is password protected, enter it when prompted.



If no password is required, the in.touch will connect automatically.

Once the in.touch module is connected to a Wi-Fi network, a green check mark will appear in the Wi-Fi menu and the network name will appear in the *Settings* menu.

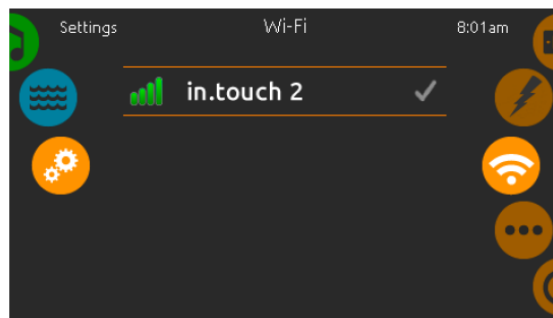
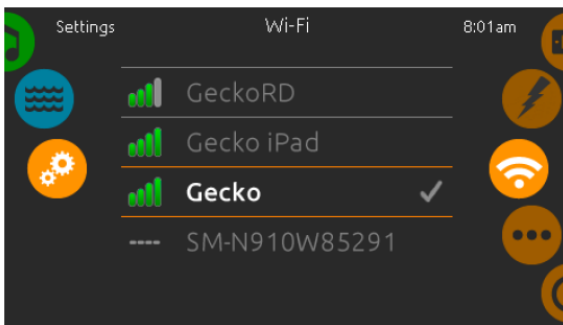

Wi-Fi (in.touch 2)

When a in.touch 2 is detected, this network will appear.

audio mode (optional)

(only available if the system detects a connected in.stream 2 audio station)

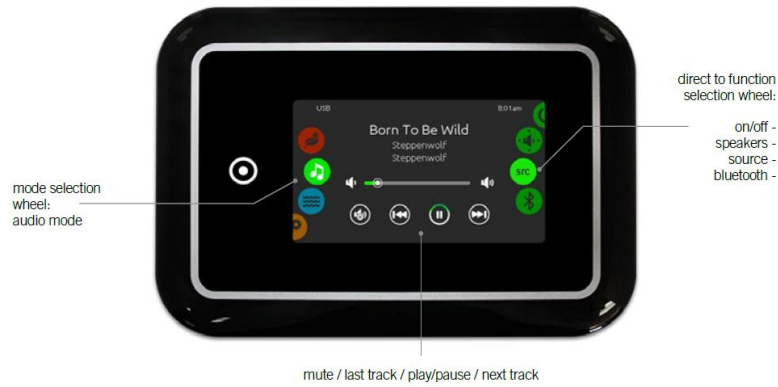

To select the audio mode, slide the left wheel up or down until the audio icon menu is highlighted in the middle.

In the Audio page you can access the following:

- in.stream 2 on/off
- speaker calibration
- audio source selector
- disconnect bluetooth

To select an item, slide the right wheel until the desired icon is highlighted in the middle.

on/off

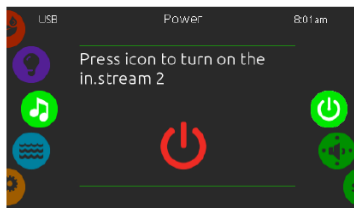

turn in.stream 2 ON (icon red)

Slide the right wheel until the power on/off icon is highlighted in the middle. Press the icon at the center of the screen to turn in.stream 2 on.

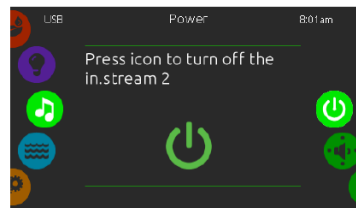

turn in.stream 2 OFF (icon green)

Press the icon at the center of the screen to turn in.stream 2 off.



main display

Press Play / Pause to start or pause playback of audio files.

Drag the volume slider to adjust the volume or tap the mute button to mute or unmute sound.

Press the last track or next track buttons to go to the previous song or skip to the next.

speakers setting

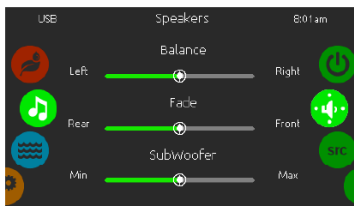

to modify your speaker settings

Slide the right wheel until the speaker calibration icon is highlighted in the middle.

You can adjust:

- balance
- fade
- subwoofer

Use the sliders to change the speaker settings at the desired level.

The fade and subwoofer sliders will only appear on the screen if the corresponding speakers are installed on the in.stream 2.

disconnect bluetooth

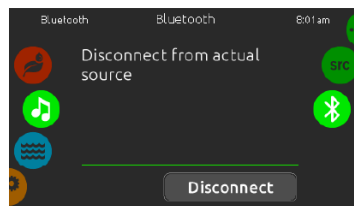

If a device with Bluetooth technology is connected to the in.stream 2, you can disconnect it by pressing the Disconnect key at the bottom of the screen.

Doing so will also prevent the in.stream 2 from automatically reconnecting to this specific device until it has been reconnected using the device itself.

IN TOUCH 2 WIFI GECKO (OPTIONAL)

WEB SITE AVAILABLE (VIDEO) FOR:

WELCOME : <https://geckointouch.com>

APPLICATION AVAILABLE IN ANDROID – IOS : <https://geckointouch.com/application#app>

and features of your spa from your smartphone or your tablet.

Even when you're away from home, you get a full control of your water-care settings, filtration cycles, water temperature, economy modes and a lot more. Push notifications will always keep you informed on the status of your spa, even when your app is not open.



You can get and download the iOS (8.0 or higher) and Android (2.3 or higher) in.touch 2 apps from the [AppStore](#) and the [Google Play store](#).

INSTALLATION INTOUCH 2 / VIDEO : <https://geckointouch.com/setup#simplest-of-setups>

Set-up your Wi-Fi on your iOS or Android smartphone or tablet

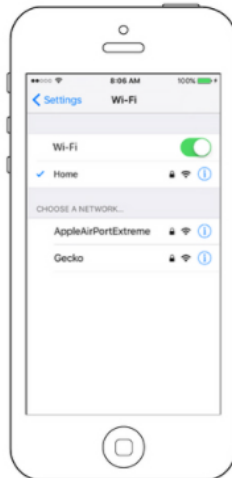

Before using your in.touch 2 app, go to the Wi-Fi section of your device's settings. Make sure you are connected to your home network through the same router you have connected your home transmitter to.

installing the home transmitter

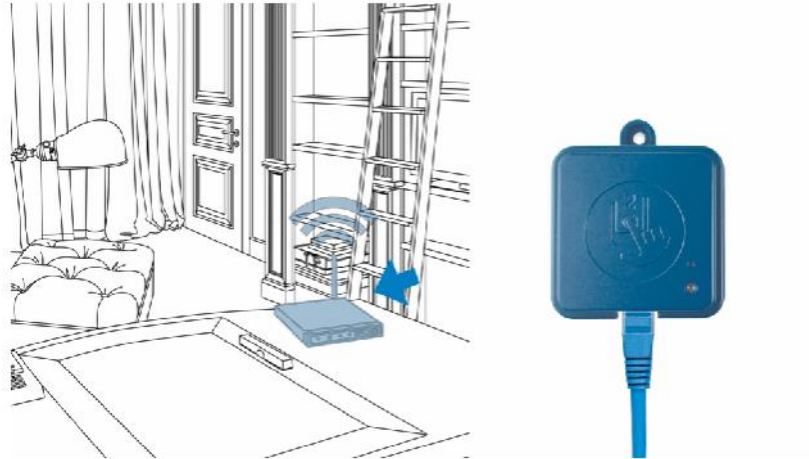

The home transmitter is provided with an ethernet cable and a power supply.

The in.touch 2 home transmitter unit must be installed inside the house, connected to a router and powered by the provided wall transformer. A longer ethernet cable may be used to bring the home transmitter closer to the spa.

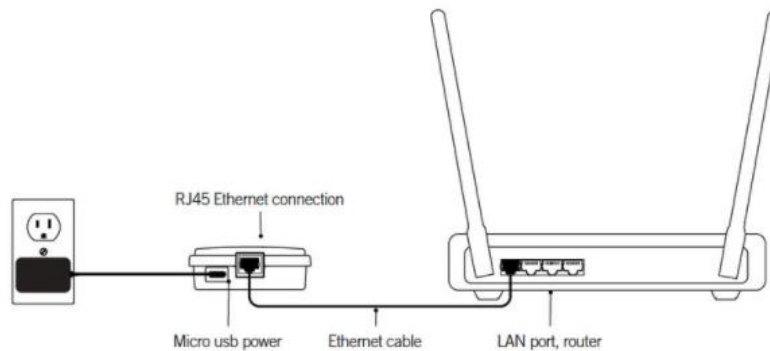

Simply connect the ethernet cable into the RJ45 port of the in.touch 2 home transmitter and in one of the available LAN ports on your router. To power up the home transmitter, plug the provided wall outlet charger to a 120V (North American model) or 220V (European model) household supply and connect the USB cable to the wall outlet and the home transmitter.

installing the spa transmitter

If you purchased a spa with in.touch 2 as a standard feature or as an option, note that the spa transmitter will be pre-installed.

To ensure proper signal transmission, it may be necessary to change the position of the transmitter once the spa is installed in the yard. The transmitter should be located on the side of the spa facing the house.



The in.touch 2 spa transmitter must be installed under the spa skirt, at least 12" (30 cm) away from any metal component or structure, as close as possible to the house to optimize the signal strength.

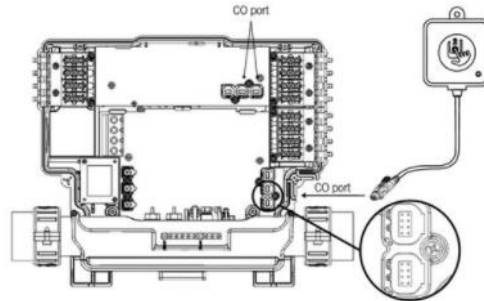

Simply connect the spa transmitter into an available CO port of the spa control system (or any other accessory with a free CO port, such as the in.stream 2 audio amplifier, or the in.clear water sanitation system).

pairing the home and spa transmitters

If you bought an in.touch 2 equipped spa or a complete retrofit kit, both transmitters of your in.touch 2 will be factory pre-paired.

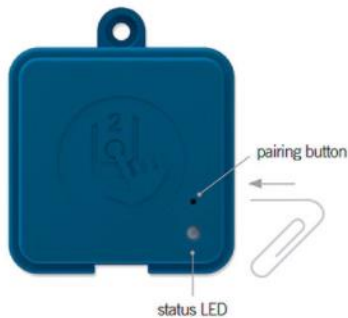

If you need to replace a transmitter or pair your transmitters again, power up the home transmitter and press on its pairing button with a paper clip. The status light of the transmitter will blink yellow.

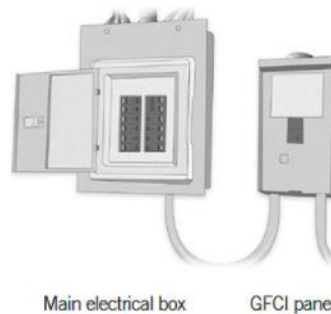

Then, shut off the spa's breaker to turn the spa transmitter off. Wait a little and put the breaker back on. Within a few seconds, pairing will be completed and both transmitter status lights will turn to blue.

transmitters status LED indicator

Both the home and spa transmitters have color status LED that can be used for troubleshooting purposes.



pairing mode	yellow (blinking)
router not detected	red
router detected	green
in.touch 2 server detected module is fully functional	blue

pairing mode	yellow (blinking)
router not detected	red
in.touch 2 server detected module is fully functional	blue

* When the LED status is blinking (blue, green or red) this indicates that the communication between the EN module and the CO module it not established.

Signal de communication fort et à longue portée

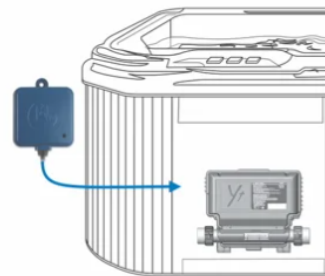
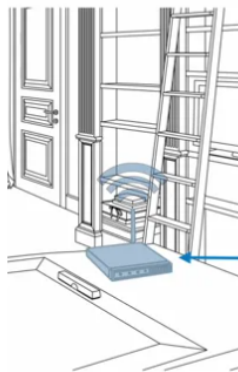

WARRANTY

ELEMENTS	YEAR OF WARRANTY ON PARTS	LABOR CREDIT
WATERPROOFING OF THE TANK	15 YEARS	N/A
SURFACE ACRYLIC	2 YEARS	N/A
STRUCTURE / FRAME	2 YEARS	N/A
ELECTRONIC PACK	2 YEARS	N/A
PUMPS	2 YEARS	N/A
KEYPAD	2 YEARS	N/A
PIPING	2 YEARS	N/A
VULCANO (920)	2 YEARS	N/A
WATER JETS / AIR JETS	1 YEAR	N/A
IN STREAM (OPTION 910 / 920)	1 YEAR	N/A
LIGHTS	1 YEAR	N/A
WIFI (IN TOUCH 2)	1 YEAR	N/A
CABINET	2 YEARS	N/A
COVER	1 YEAR	N/A
PILLOWS	1 YEAR	N/A
SPEAKER & SUBWOOFER	1 YEAR	N/A
OZONE/OZONE UV	1 YEAR	N/A
FUSE	N/A	N/A

The warranty excludes any transport compensation.

The warranty excludes any damage from freezing or thaw.

The warranty excludes any damage from an unlevelled surface.

The warranty excludes any leakage from the pump ring and the pack.

Headrest warranty does not cover chemical damage.

The warranty does not apply to Ozone/Ozone UV option if NOT installed in our factory.



**The acrylic warranty does not cover damage caused by Trichlor.
Use of a float voids the acrylic warranty.**

805 Boulevard Cristini – Lachute – (QC) – J8H 4N6 – Canada
Tél : +1 450 937 4441 – email : bewellcanadaspa@gmail.com

TROUBLESHOOTING



Troubleshooting

Possible error codes on in.yj, in.ye, in.yt and in.xe control systems

The error codes indicate a failure or problem that must be rectified to guarantee the good function of the system. The error code and the water temperature are displayed alternately on the keypad.

The error messages listed below display on the LCD and LED keypads. If your spa is equipped with a color keypad, please refer your [techbook](#) for more information on error messages.



HL

The water temperature in the water heater has reached 119 °F (48°C).

Do not enter spa water!



Prr

The system detects a problem with the regulation probe. The system constantly verifies if the temperatures read by the probe are inside the normal limits.



FLO

The system has detected no water flow during the main pumps operation.



UPL

No low-level configuration is present in the control system memory, insert a valid in.stik to program the control unit.



AOH

The temperature inside the spa skirt is too high and causes an increase of the internal temperature of the control system above normal limits.



OH

The spas water temperature has reached 108°F (42°C)

Do not enter spa water!



Hr

An internal error with the system hardware has been detected.

Note: Only on in.xe control, can't be displayed with a in.k330 keypad.